

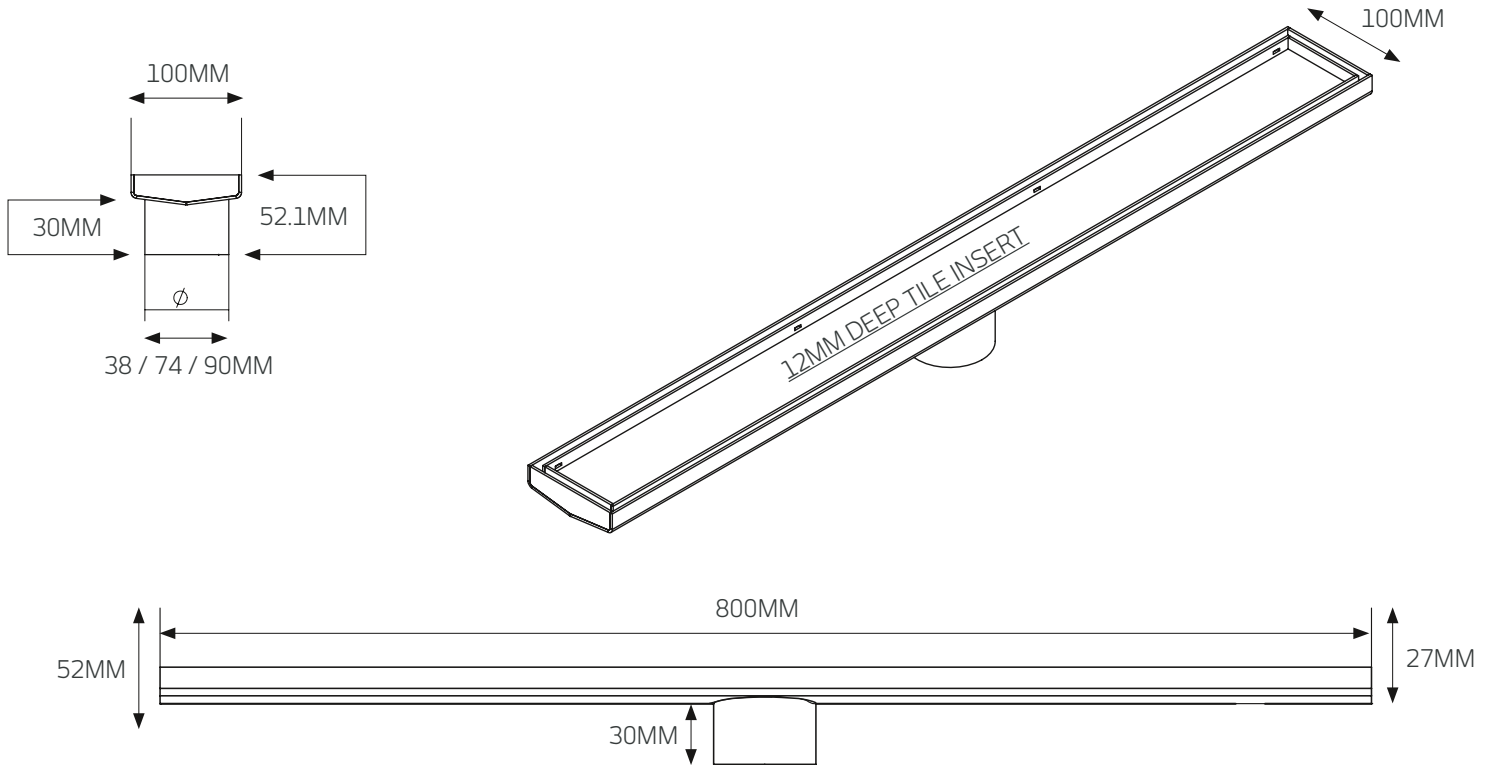





# SHOWER GRATES *specifications*

## 316-RGL-800 – 800 x 100 x 38/74/90mm



FEATURES	CODE	SIZE (MM)	COLOURS
• 316 Marine Grade Stainless Steel	316-RGL-800-38	800x100x38	Stainless Steel 
• Width: 800	316-RGL-800-74	800x100x74	Stainless Steel 
• Height: 100 mm	316-RGL-800-90	800x100x90	Stainless Steel 
• Rolled edges to all exposed edges	316-BLK-RGL-800-74	800x100x74	Matt Black 
• Matt Black grates are Teflon Coated	316-GLD-RGL-800-38	800x100x38	Brushed Gold 
• Brushed Gold grates are PVD Coated	316-GLD-RGL-800-74	800x100x74	Brushed Gold 
• 12 mm deep insert can accommodate up to 10 mm tile + adhesive			
• With fixed central wastes			
• Covered by a 7 year warranty *			

\* The replacement warranty for the coated grates are only applicable until the date of installation. Once Installed any damage to the coatings due to the incorrect use of cleaning products, mis-use or accidental damage, will not be covered under warranty.